

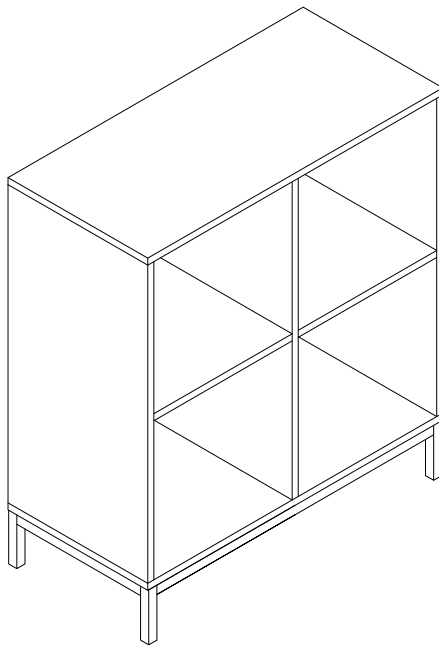

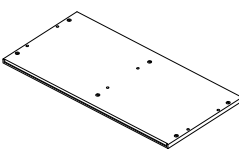

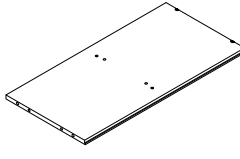

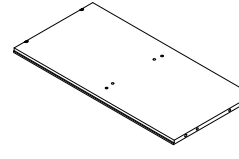
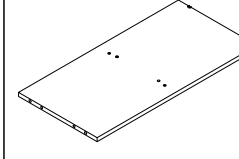
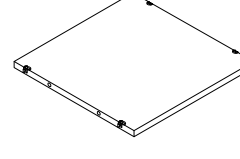
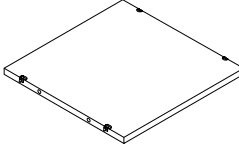
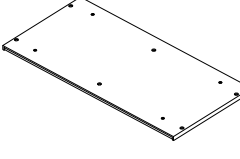
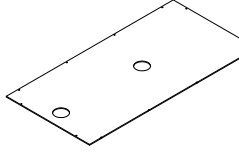
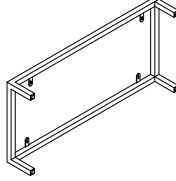

Record Storage Cube Bookcase
CF1315

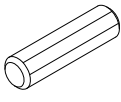
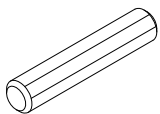
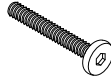

PART LIST

A 	B 	C 	D 	E 
Top Panel 1 PC	Left Panel 1 PC	Right Panel 1 PC	Middle Partition Panel 1 PC	Left Fixed Panel 1 PC
F 	G 	H 	I 	
Right Fixed Panel 1 PC	Bottom Panel 1 PC	Back Panel 2 PCS	Base 1 PC	

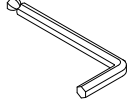
HARDWARE LIST

#1 	#2 	#3 	#4 	#5 
Ø8*30mm Wood Dowel 16 PCS (Extra 1)	Ø8*50mm Long Wood Dowel 2 PCS (Extra 1)	1-1/2"*Ø1/4"*D11mm Long Bolt 6 PCS (Extra 1)	1/2"*Ø1/4"*D11mm Short Bolt 4 PCS (Extra 1)	Flat Washer 4 PCS
#6 	#7 	#8 		
Screw 20 PCS (Extra 1)	Allen Wrench 1 PC	Safety Strap Kit 1 SET		

ADDITIONAL TOOLS (Not Provided)

Note: It is not recommended to use power tools during assembly.

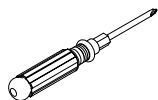

Phillips Head Screwdriver

Note: Wood dowels are intended for alignment. Additional clearance between wood dowel and pre-drilled hole is intentional for ease of assembly.

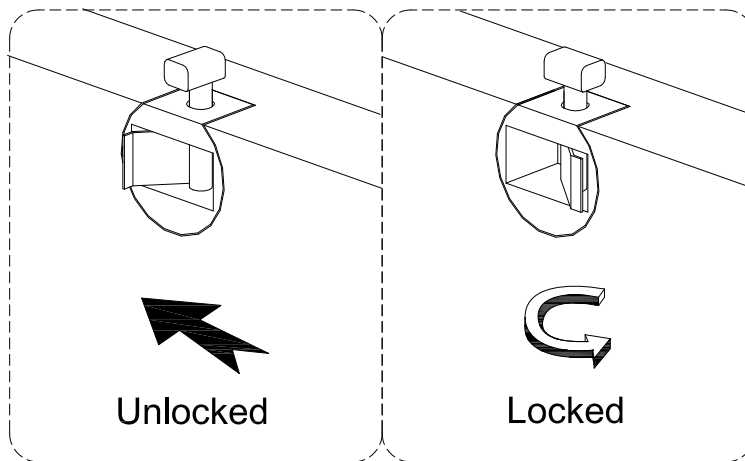

Please do not use tools to assemble this unit unless specifically indicated.

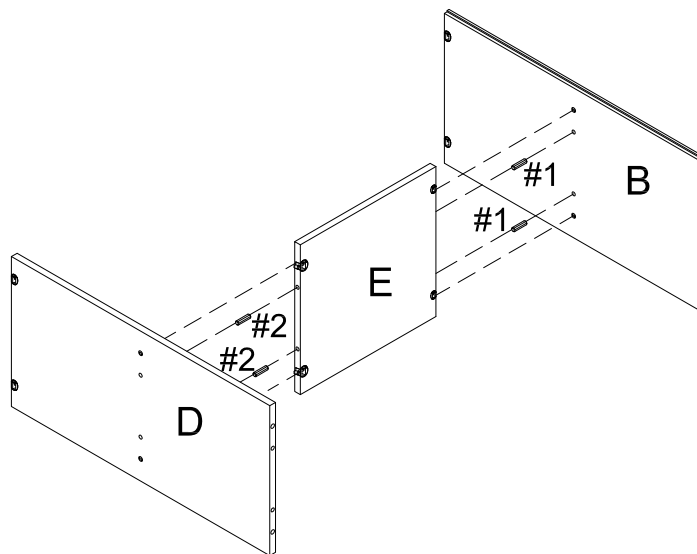

Reference the images above any time the instructions state "lock the hardware".
Note: Be sure to check all hardware is locked when completed.

Step 1. Attach left fixed panel (part E) to left panel (part B) using wood dowels (part #1) and lock the hardware. Attach middle partition panel (part D) to left fixed panel (part E) using long wood dowels (part #2) and lock the hardware.



#1  x 2
#2  x 2

Step 2. Attach right fixed panel (part F) to middle partition panel (part D) by locking the hardware.

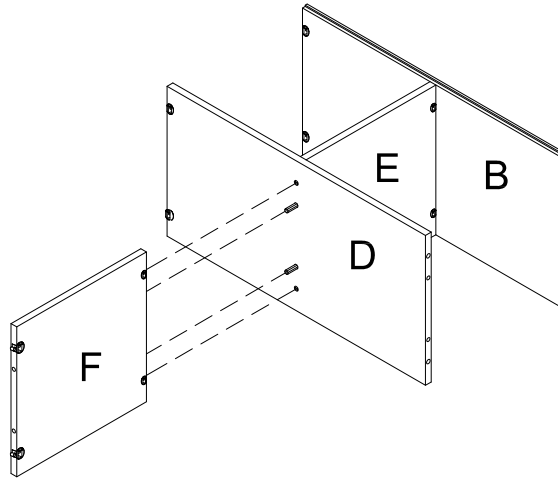

Step 3. Attach right panel (part C) to right fixed panel (part F) using wood dowels (part #1) and lock the hardware.

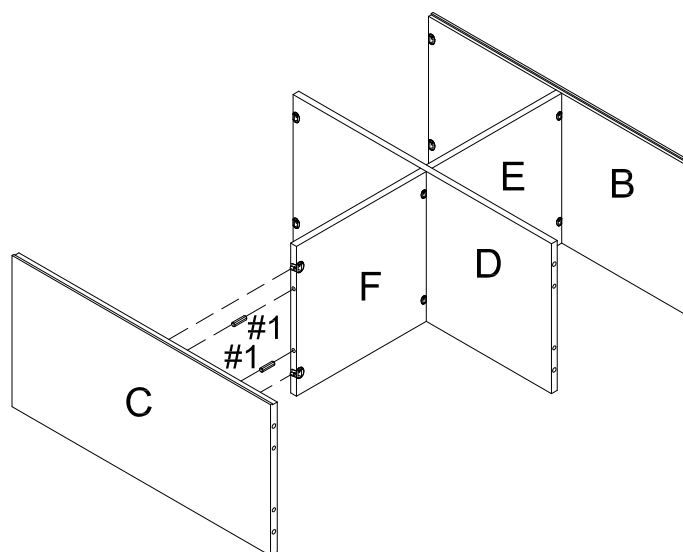

#1  x 2

Step 4. Attach top panel (part A) to assembled unit (parts B, C & D) using wood dowels (part #1) and lock the hardware. Attach bottom panel (part G) to assembled unit (parts B, C & D) using wood dowels (part #1), long bolts (part #3) and allen wrench (part #7).

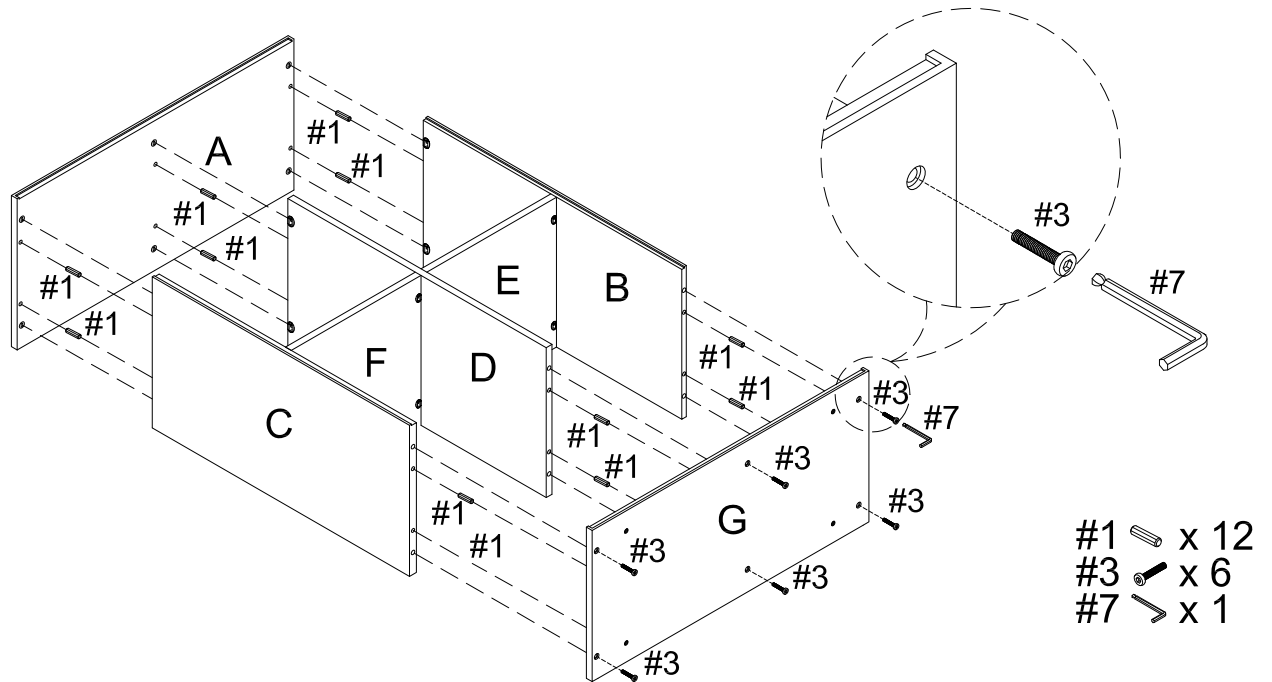

Step 5. Attach back panels (part H) to assembled unit (parts A, B, C, D & G) using screws (part #6) and phillips head screwdriver.

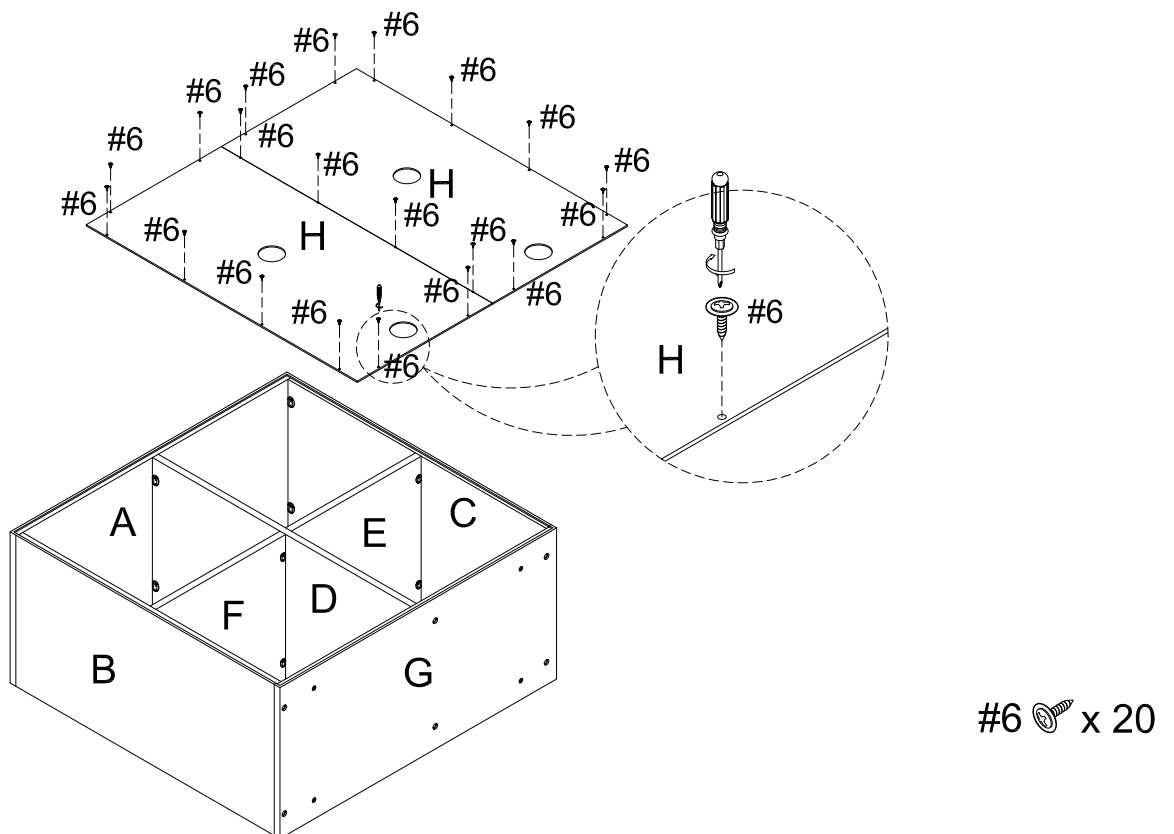





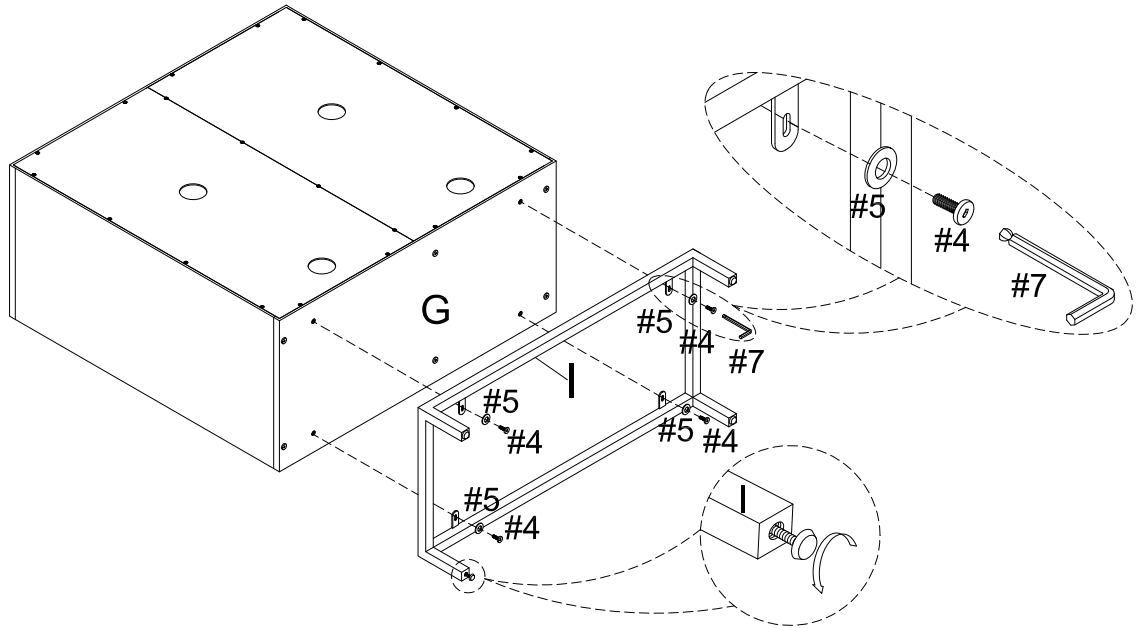

Step 6. Attach base (part # I) to bottom panel (part G) using short bolts (part #4), flat washers (part #5) and allen wrench (part #7).

NOTE: It is important to adjust levelers once fully assembled and upright. Extend adjustable leveler until it's firmly in contact with the floor. If relocating, adjust leveler as needed until it's firmly in contact with the floor in new location.

Important: Safety strap kit (part #8) must be installed to prevent tipping, damage and/or injury.

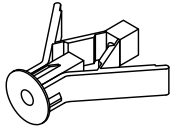

#4  x 4
#5  x 4
#7  x 1

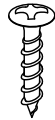
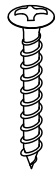
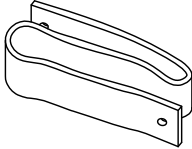
#8 	A 	B 	C  D8*3/4"	D  D8*1-1/2"	E 
Safety Strap Kit 1 SET	Wall Anchor 1 PC	Washer 2 PCS	Short Screw 1 PC	Long Screw 1 PC	Safety Wall Strap 1 PC

SAFETY WALL STRAP INSTALLATION

Note: It is highly recommended to install this safety strap kit to prevent tipping, damage and/or injury.

1. Insert short screw (C) through washer (B) and safety wall strap (E) and attach to top panel (part A) using phillips head screwdriver.



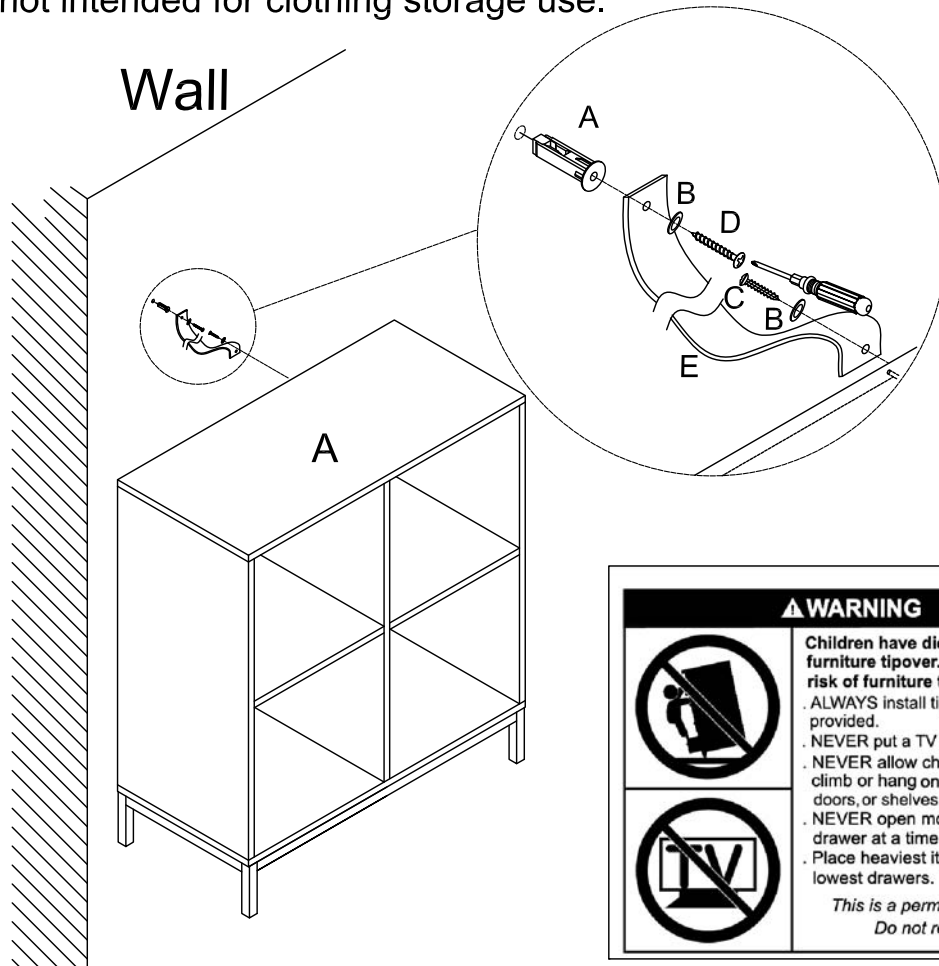

2. Drill a 11/32" hole where you want to secure the unit. The drilled hole will be at the same height as the hole in top panel (part A) where the safety wall strap (E) is attached. Tap wall anchor (A) into the hole.

3. Insert long screw (D) through washer (B) and safety wall strap (E) into wall anchor (A) using phillips head screwdriver.

Note: This item is not intended for clothing storage use.

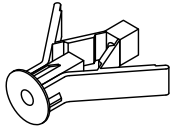

⚠ WARNING	
	<p>Children have died from furniture tipover. To reduce the risk of furniture tipover:</p> <ul style="list-style-type: none"> • ALWAYS install tipover restraint provided. • NEVER put a TV on this product. • NEVER allow children to stand, climb or hang on drawers, doors, or shelves. • NEVER open more than one drawer at a time. • Place heaviest items in the lowest drawers.
	<p style="text-align: center;"><i>This is a permanent label. Do not remove!</i></p>

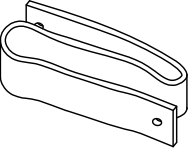
#8	A	B	C	D	E
			 D8*3/4"	 D8*1-1/2"	
Safety Strap Kit 1 SET	Wall Anchor 1 PC	Washer 2 PCS	Short Screw 1 PC	Long Screw 1 PC	Safety Wall Strap 1 PC

SAFETY WALL STRAP INSTALLATION

Note: It is highly recommended to install this safety strap kit to prevent tipping, damage and/or injury.

1. Insert short screw (C) through washer (B) and safety wall strap (E) and attach to top panel (part A) using phillips head screwdriver.

2. Drill a 11/32" hole where you want to secure the unit. The drilled hole will be at the same height as the hole in top panel (part A) where the safety wall strap (E) is attached. Tap wall anchor (A) into the hole.

3. Insert long screw (D) through washer (B) and safety wall strap (E) into wall anchor (A) using phillips head screwdriver.

Note: This item is not intended for clothing storage use.

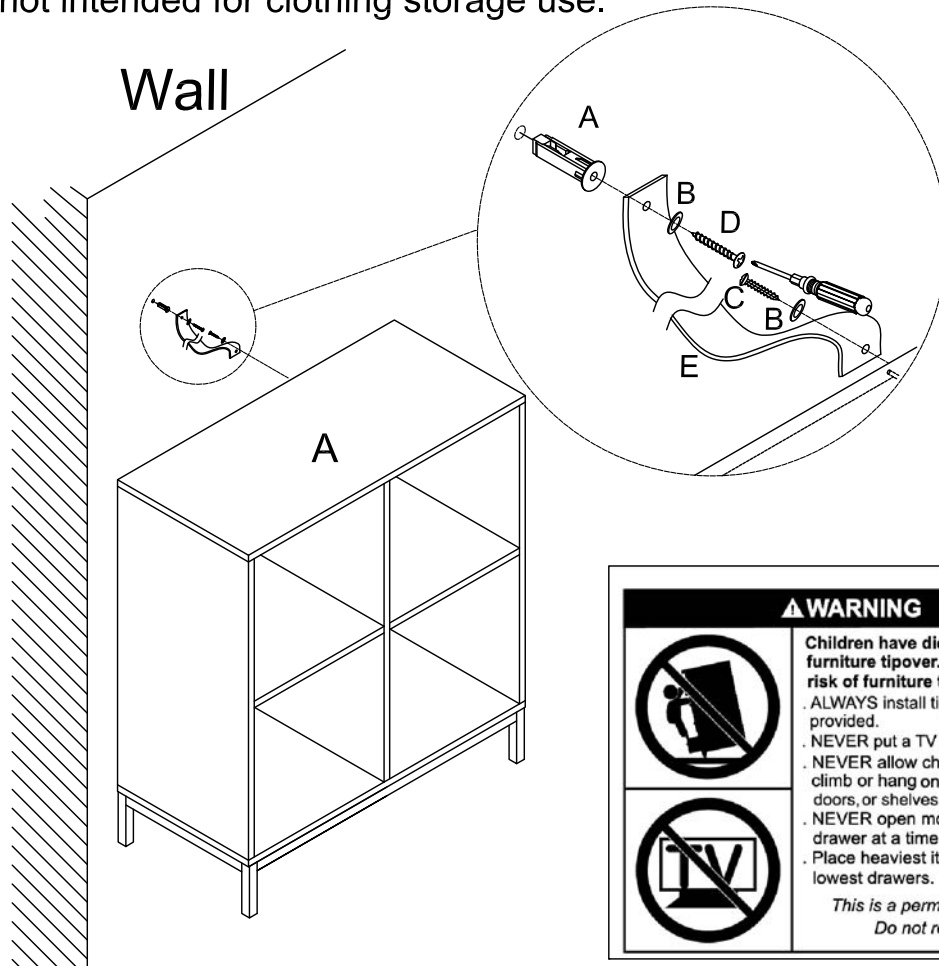

▲ WARNING	
	Children have died from furniture tipover. To reduce the risk of furniture tipover:
	<ul style="list-style-type: none"> · ALWAYS install tipover restraint provided. · NEVER put a TV on this product. · NEVER allow children to stand, climb or hang on drawers, doors, or shelves. · NEVER open more than one drawer at a time. · Place heaviest items in the lowest drawers.
<i>This is a permanent label. Do not remove!</i>	